

NOTE: All measurements must be taken from the Top of the Door

CHOOSE **V**

- KE31-1
- KE32-1
- KE33-2
- KE35-1
- KE37-1
- KE33-1
- KE34-1
- KE36-1
- KE38-1

HANDING:

- LH/RHR ACTIVE
- RH/LHR ACTIVE

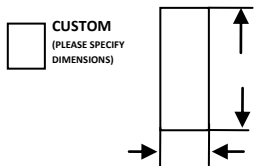
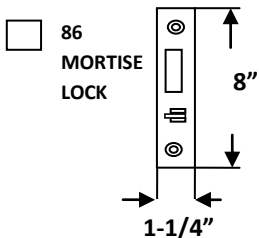
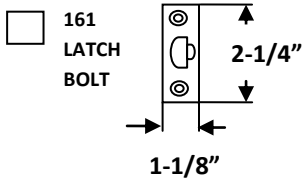

- FIRE BOLT
- SPECIFY HOLE SIZE _____
- MANUFACTURER _____

TOP OF DOOR

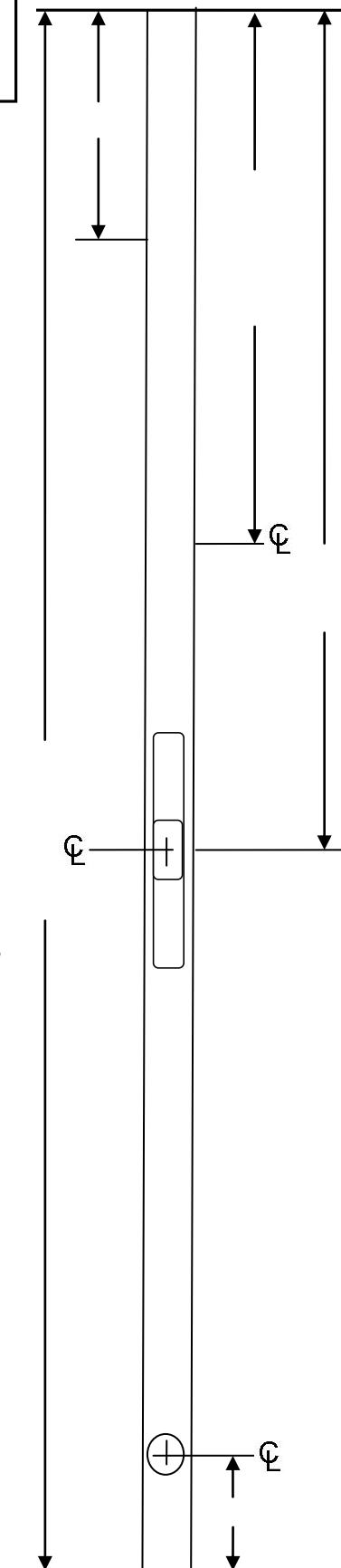

- WITH "UL" LABEL
- FOR USE ON 1-3/4" DOOR
- FOR USE ON ____" DOOR

TYPE:

- MORTISE
- NON-MORTISE

QUANTITY: _____

DOOR EDGE:

- SQUARE
- BEVEL

BUTT HINGE SIZE:

- 4-1/2" X 4-1/2"
- 5" X 5"
- CUSTOM

BACKSET _____

DOOR TAG INFO.

SPECIAL INSTRUCTIONS

TOP OF DOOR TO TOP OF BUTT HINGE

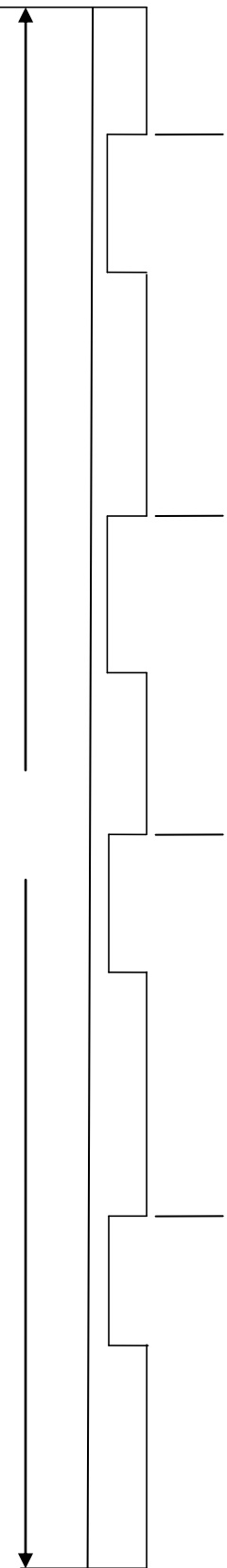

The undersigned approved the design and dimensions as shown, and authorize the fabricator of these edge guards as indicated.

CUSTOMER _____

PO # _____

SIGNED: _____

NOTE: All measurements must be taken from the Top of the Door

TOP OF DOOR

TOP OF DOOR TO TOP OF BUTT HINDGE

CHOOSE

- KE31-1
- KE32-1
- KE33-1
- KE33-2
- KE34-1
- KE35-1
- KE36-1
- KE37-1
- KE38-1

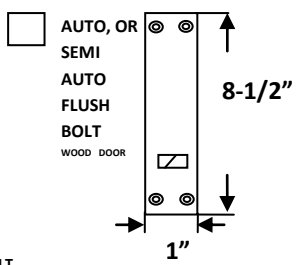
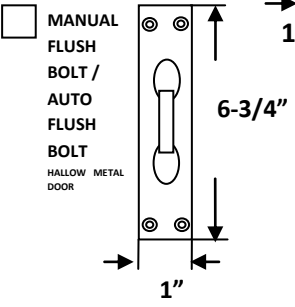
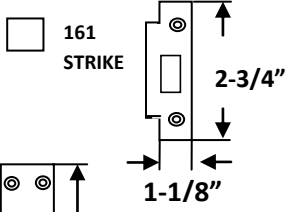
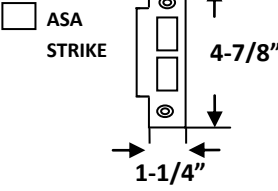

FIRE BOLT
SPECIFY HOLE SIZE _____
MANUFACTURER _____

- WITH "UL" LABEL
- FOR USE ON 1-3/4" DOOR
- FOR USE ON ____" DOOR

TYPE:
 MORTISE
 NON-MORTISE

QUANTITY: _____

DOOR EDGE:
 SQUARE
 BEVEL

CUSTOM
(PLEASE SPECIFY DIMENSIONS)

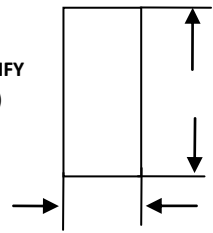

HANDING:
 LH/RHR INACTIVE
 RH/LHR INACTIVE

BUTT HINGE SIZE:
 4-1/2" X 4-1/2"
 5" X 5"
 CUSTOM

BACKSET _____

DOOR TAG INFO.

SPECIAL INSTRUCTIONS

The undersigned approved the design and dimensions as shown, and authorize the fabricator of these edge guards as indicated.

CUSTOMER _____
PO # _____

SIGNED: _____