

A	REVISED: 1-19-87
B	REVISED: 8-22-95

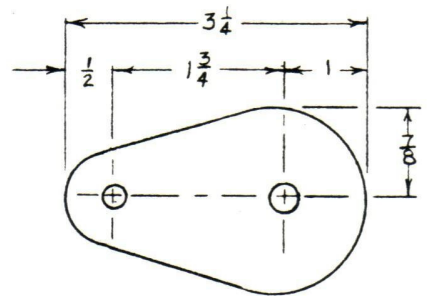

BASE

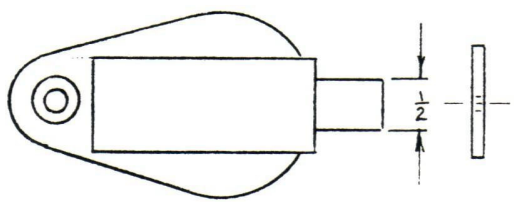
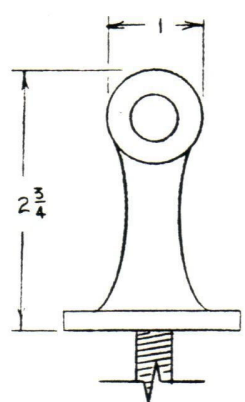
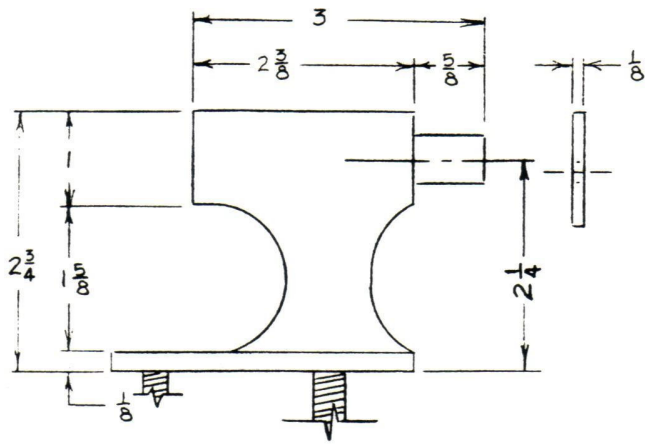
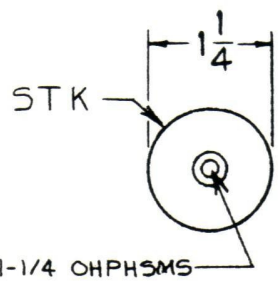

8 X 1-1/4 OHPH SMS

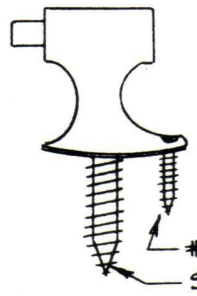

1258

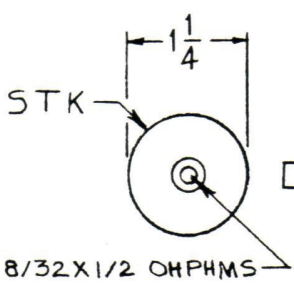

8/32 X 1/2 OHPH SMS

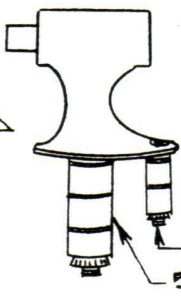

1258 M

14 X 1-1/2 FHPH SMS
SWS

1/4-20 X 1-1/4 FHPH MS XES
5/16 STUD X EX. SH

001102

DWG. NO. 11547

Trimco
Triangle Brass Manufacturing Company, Inc.
3528 Emery Street, P.O. Box 23277
Los Angeles, CA 90023, USA

1258
DOOR STOP
DR. BY: L. R.

Book No. _____ Date Requested: _____
This template is provided for use only on the job for which it was requested.
Trimco reserves the right to make design changes without notice.