

BACK PLATE

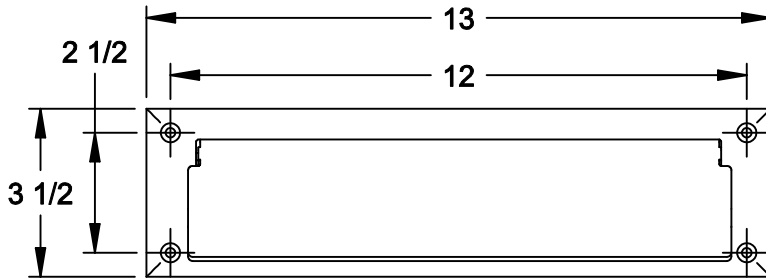

FRONT PLATE

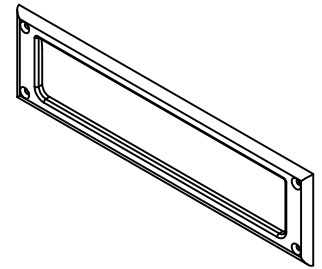
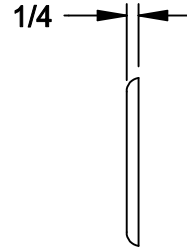
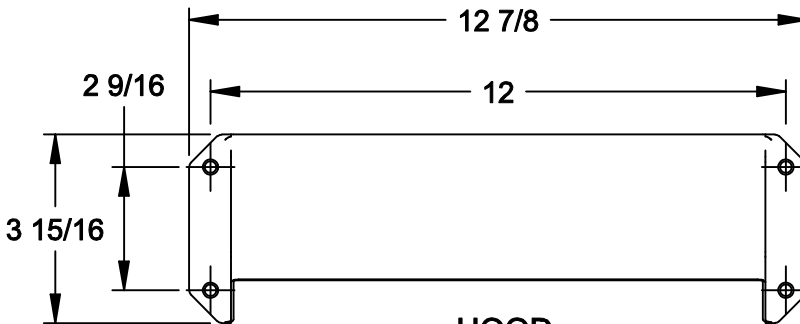
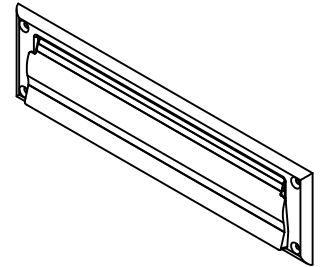
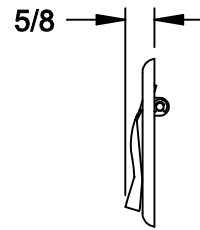

HOOD

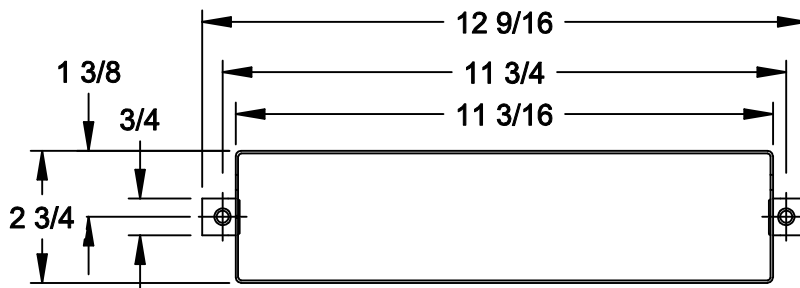
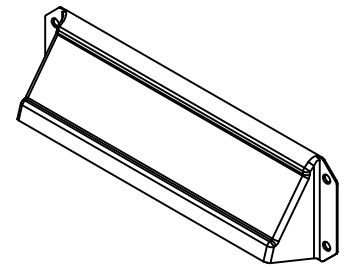
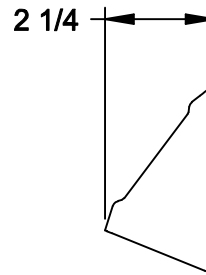

LINER

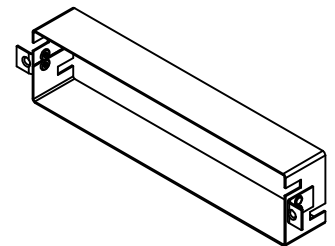
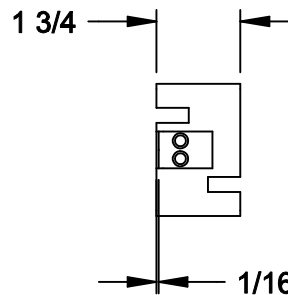

(VERIFY OVERALL DIMS WITH TAPE MEASURE BEFORE DOOR PREP, HOLE CUT OUT SHOULD BE 1/32-1/16" LARGER TO ENSURE EASE OF INSTALLATION)

SETS: 2082 - BACK AND FRONT PLATE, 2085 - FRONT PLATE AND HOOD, 2091 - LINER ONLY
SUPPLIED WITH #8 X 3/4" OVAL HEAD (FLAT HEAD FOR LINER), PHILLIPS DRIVE WOOD MOUNTING SCREWS

NOTE: This template is provided for use only on the job for which is was requested. Trimco reserves the right to make design changes without notice. Trimco will not be responsible for errors or damage caused by the use of out-of-date templates.

DATE

3/20/08

2085 SET MOUNTED WITH 2091 LINER

THE HINGE POINTS FOR THE FRONT PLATE MUST SIT IN THESE CUT OUTS IN THE LINER. (MULTIPLE CUT OUTS MADE FOR TWO MOUNTING OPTIONS)

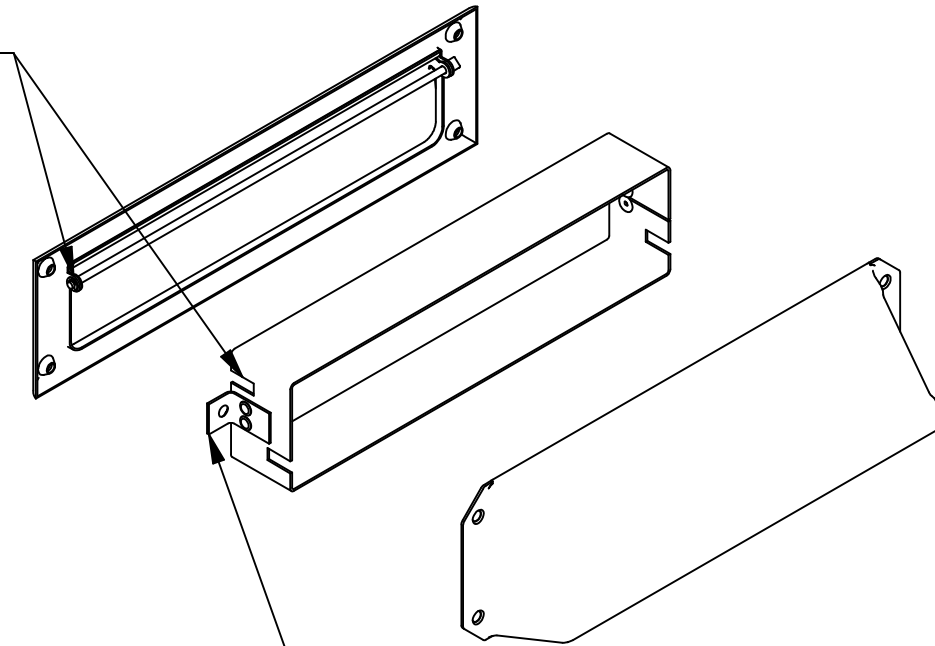

WHEN MOUNTING ON A WOODEN DOOR THESE TABS CAN BE MORTISSED INTO THE DOOR FOR FLUSH MOUNTING BENEATH THE HOOD. HOWEVER, SINCE METAL DOORS CAN NOT BE MORTISSED WE ADVISE MOUNTING AS SHOWN, WITH THESE TABS ON THE FRONT OF THE DOOR, THE FRONT PLATE MOUNTS OVER THESE TABS, EVEN WHEN NOT MORTISED.